

**MOTIVATE
YOUR LIFE !**

HT10120/HT10121/HT10122

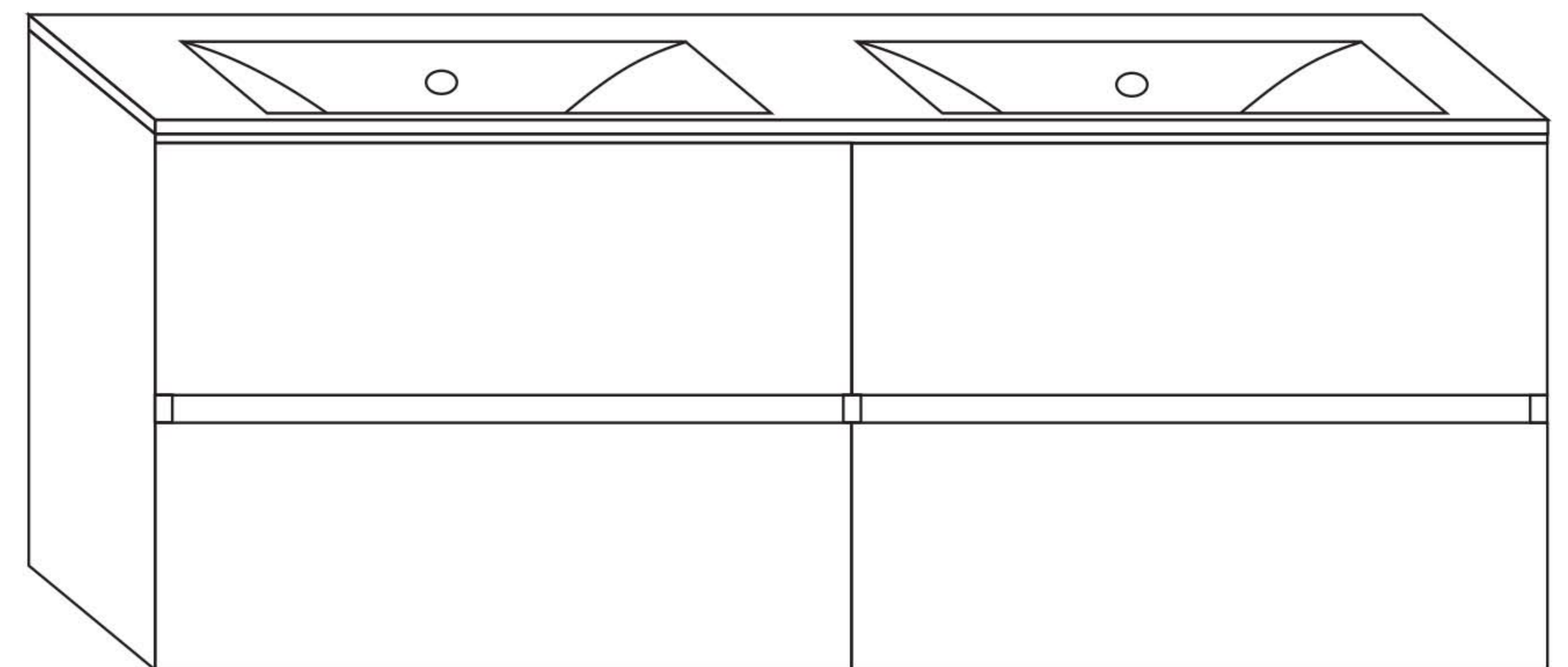





THANKS FOR WATCHING

Your feedback is invaluable to us and we would love to hear about your experience. Please take the time to leave us a review.

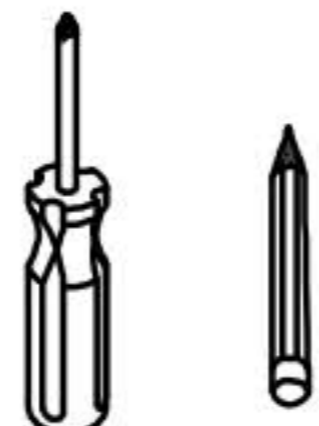
Thank you for shopping with us!

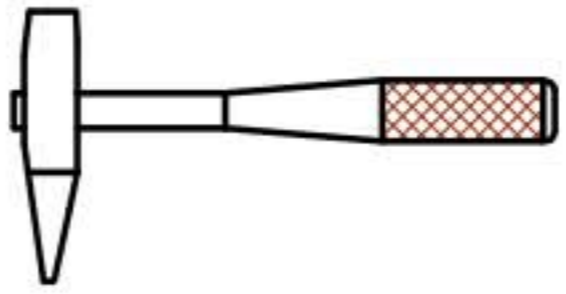







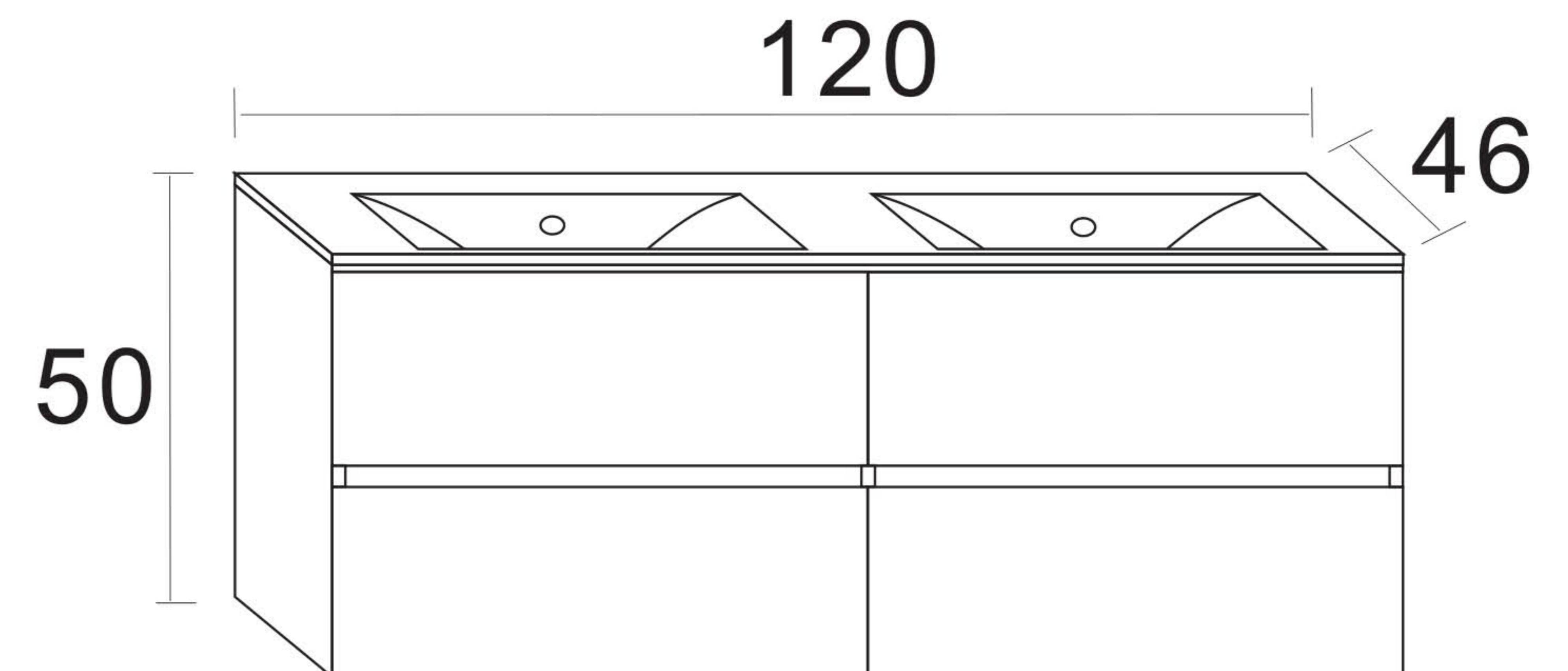

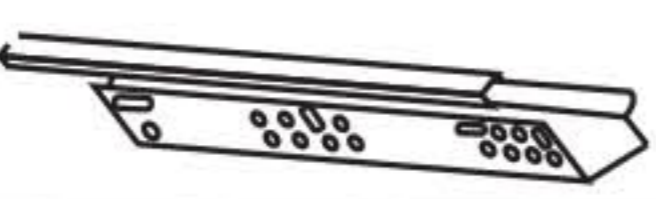

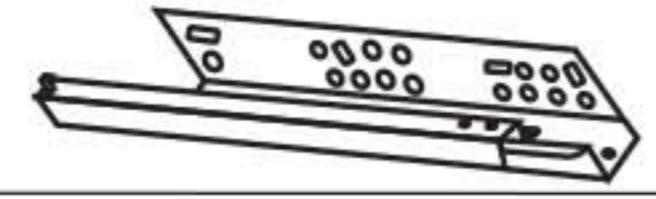





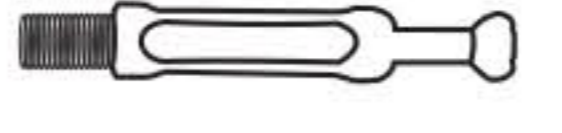





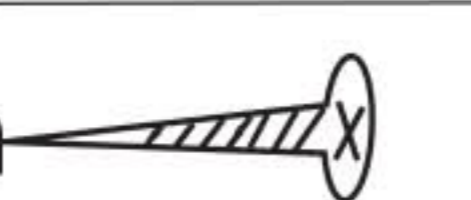
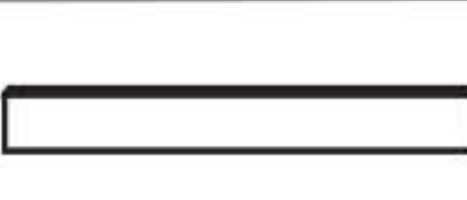
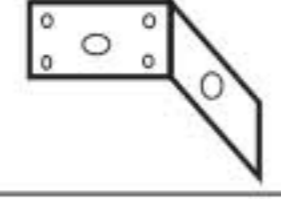

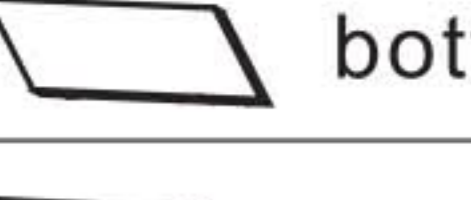
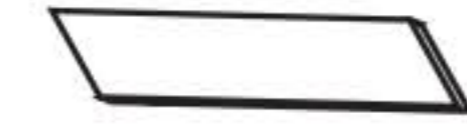

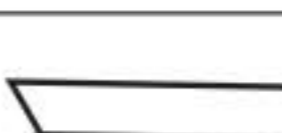

We encourage you to take a few minutes to go through this booklet. It contains important information on installation and care tips to keep your furniture looking as good as new.

Hardware			Tools		
NO.	Draw	QTY			
A		3	   		
B		3			

CARE CLEANING AND MAINTENANCE

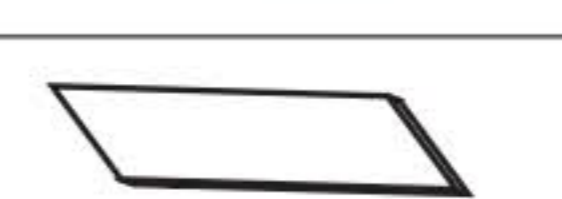
1. Dust regularly with a soft , dry cloth .
2. Avoid the use of all chemicals household cleaners, abrasives, or cleaners that contain lemon, vinegar, or other acids that may damage the finish.
3. Excessive exposure to sunlight and extreme changes in temperature and moisture can damage wood furniture .
4. The sink top is resilient, but care needs to be taken to preserve its appearance.
5. Do not place hot appliances, such as curling irons and hot hair dryers directly on the countertop. Wipe spills immediately.



a	 Left 4x	1	 Left 1x
b	 Right 4x	2	 Right 1x
c	M7*40mm  8x	3	 1x
d	Φ14  95x	4	 1x
e	 95x	5	 1x
m	18mm  8x	6	 1x
g	25mm  16x	7	 1x
j	14mm  48x	8	 2x
k	 3x	9	 bottom 4x
		10	 bottom 2x
18	 2x	11	 Left 2x
19	 4x	12	 Right 2x
20	 2x	13	 Left 2x
21	 2x	14	 Right 2x
22	 Left 2x	15	 Left 2x
23	 Right 2x	16	 Right 2x
24	 2x	17	 2x

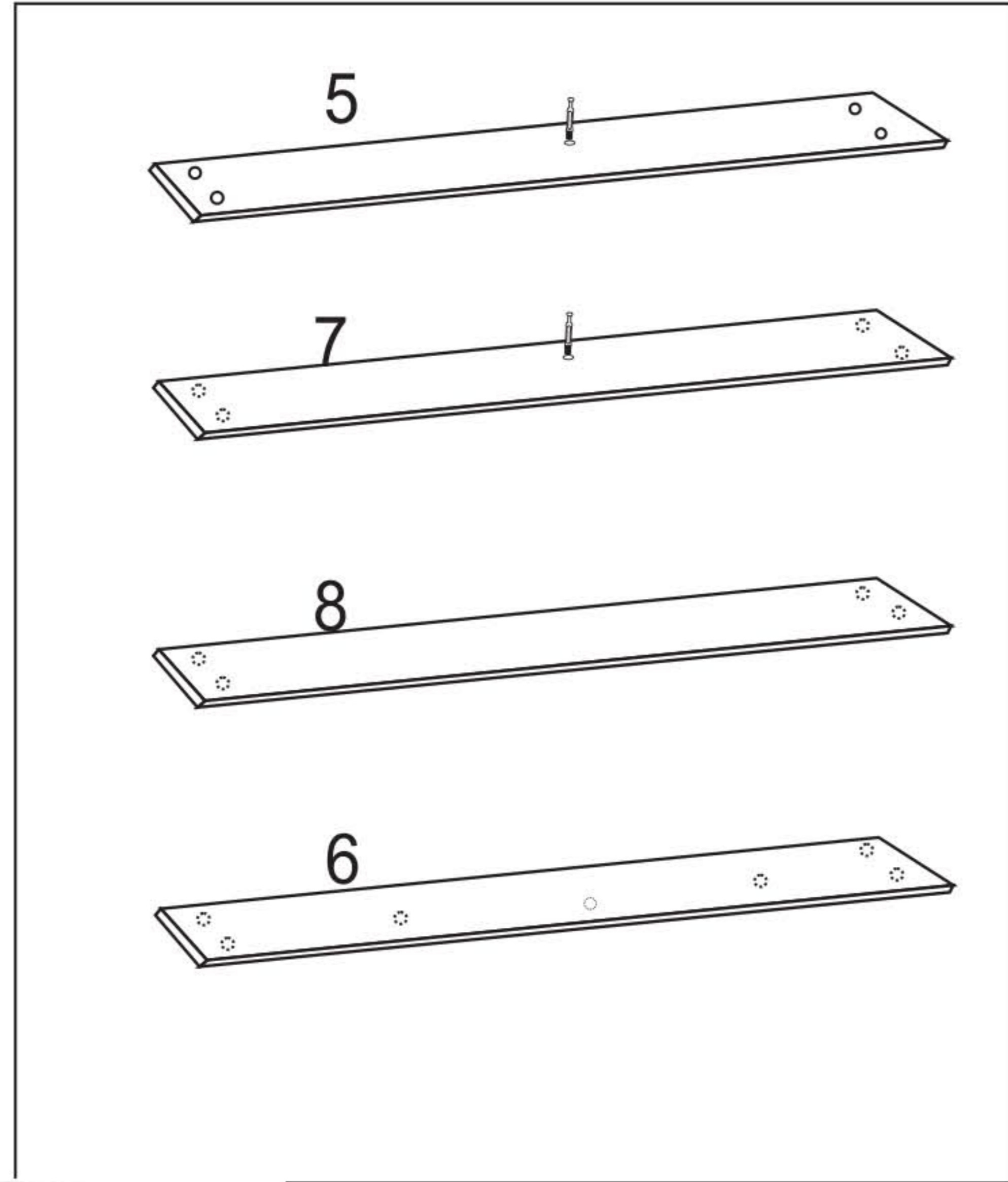
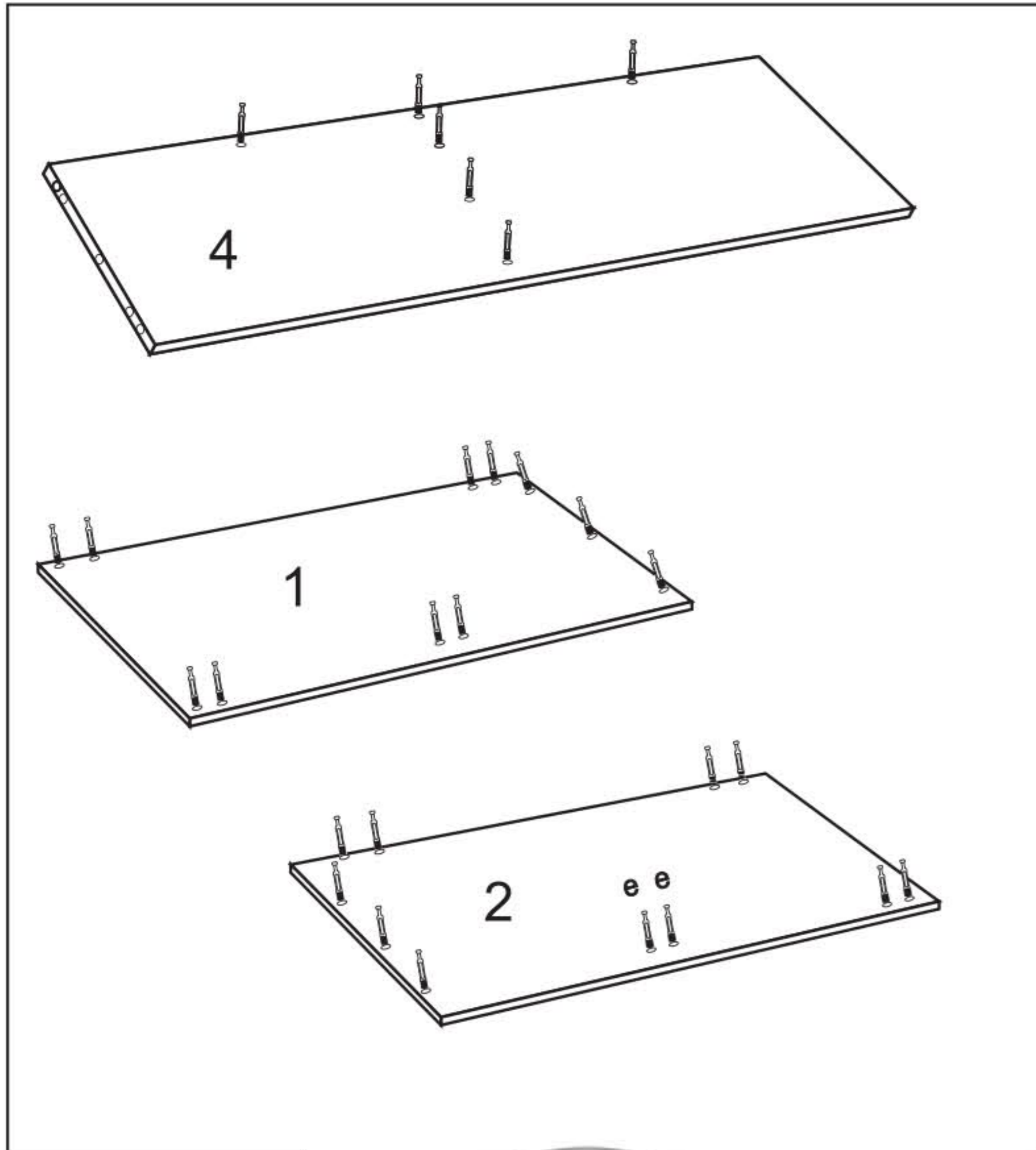
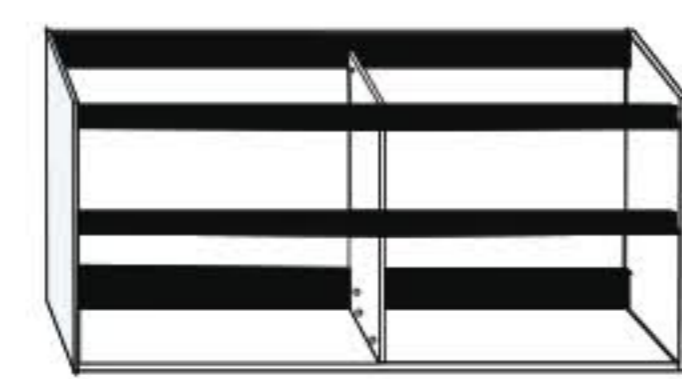
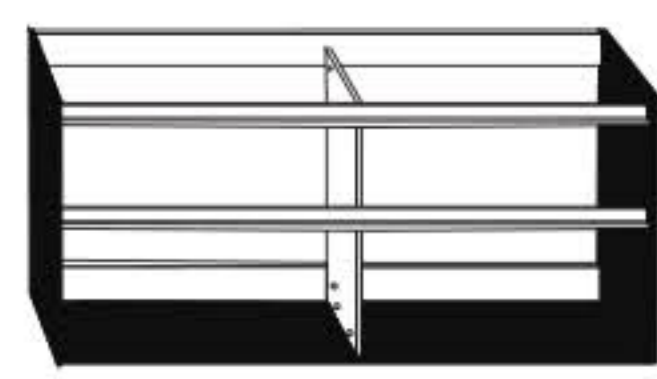

Ensure that all sliders are level and front and back at the same height. Otherwise, the slide rail will not buffered

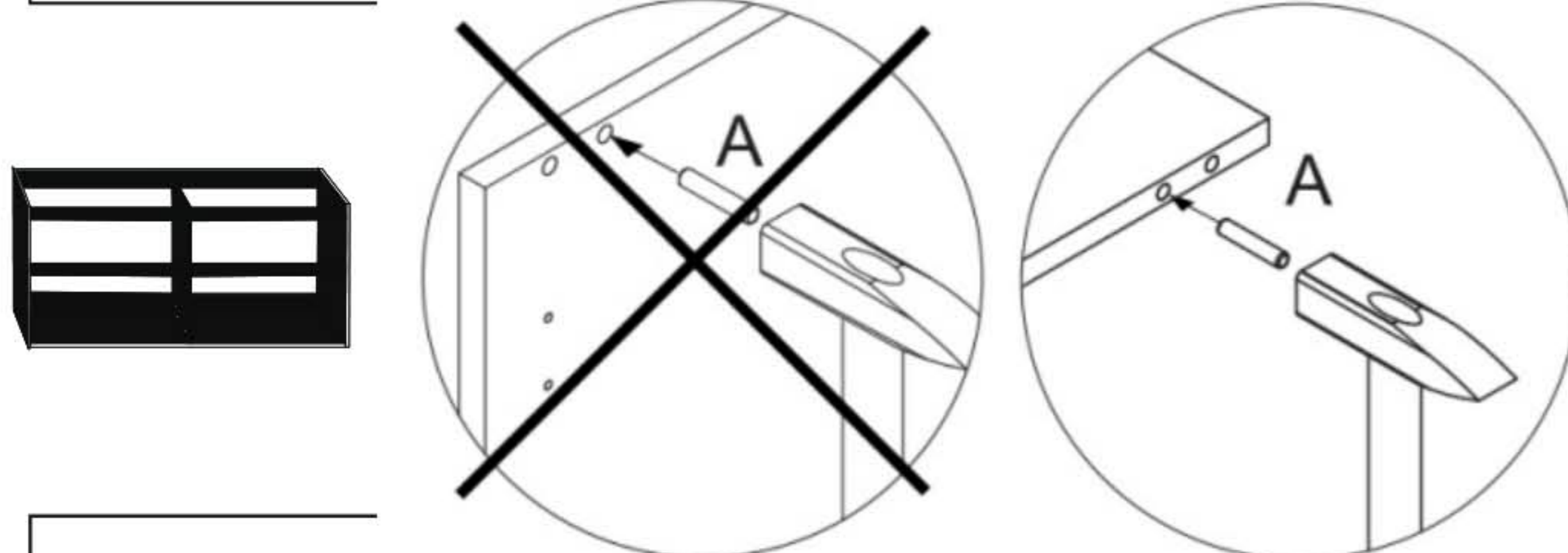
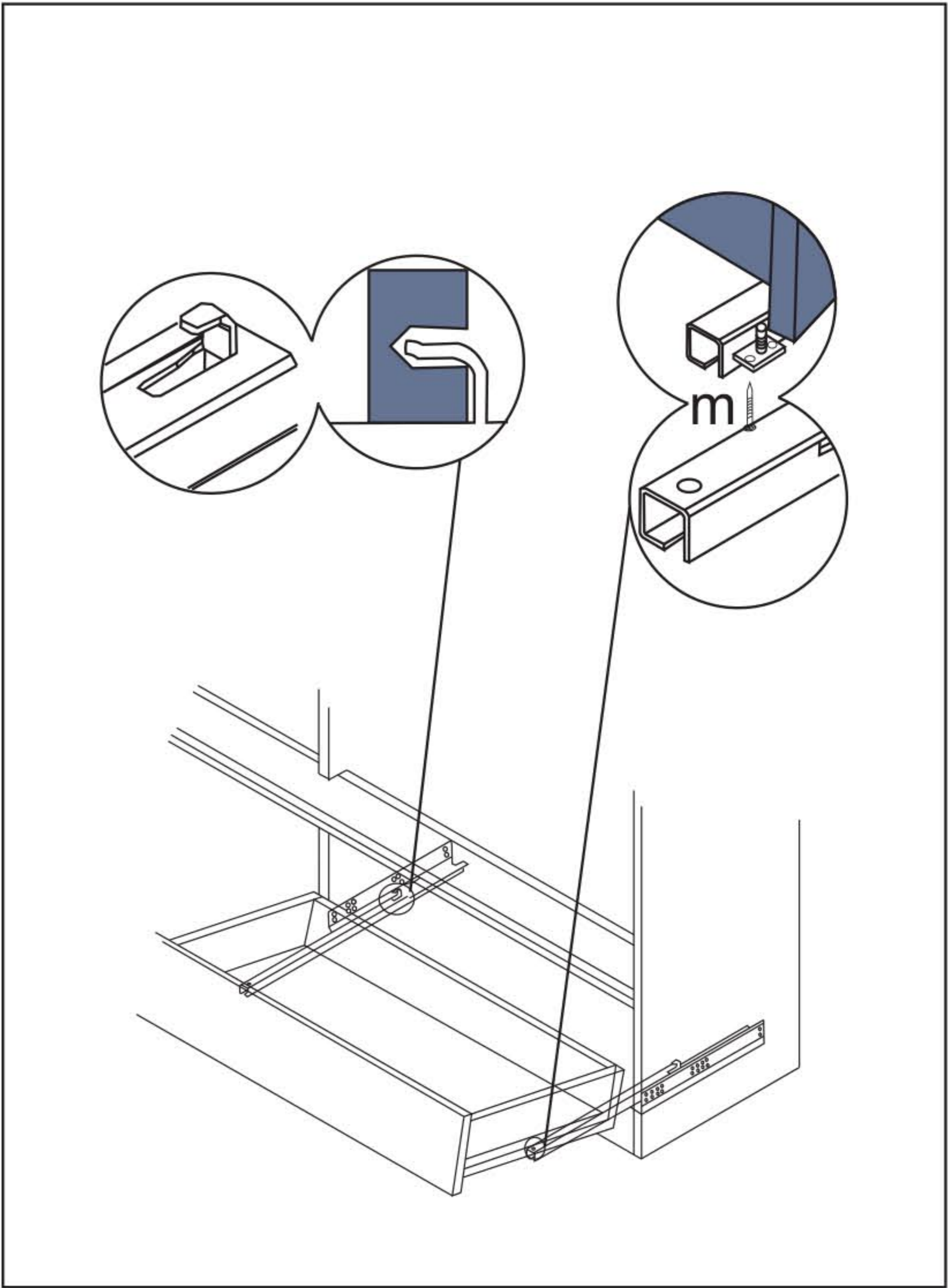

Note that the wood tips should go to the side plate first

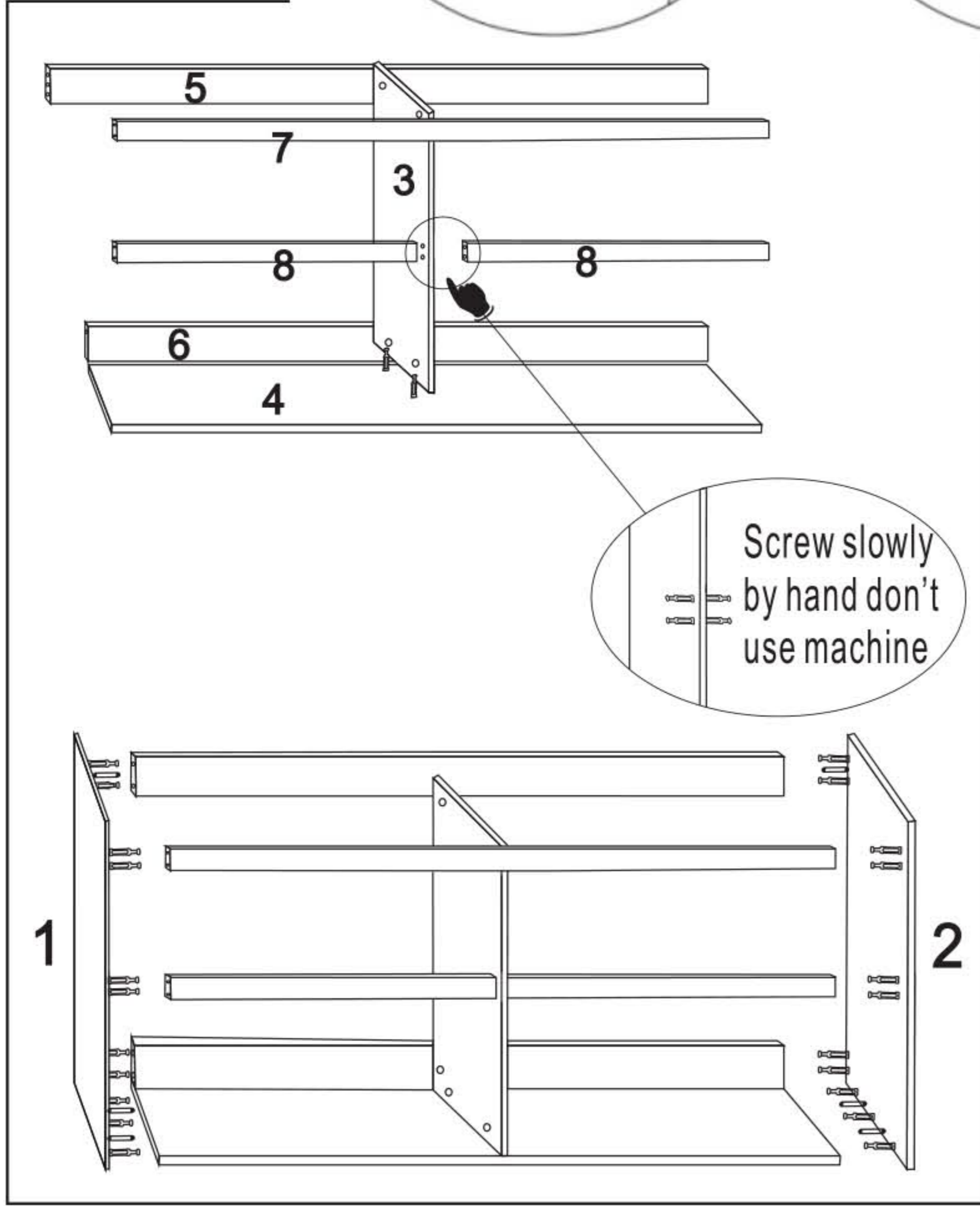

Top drawer

Bottom drawer

Note: install the lower drawers first and then the top drawers

