

WALK-IN

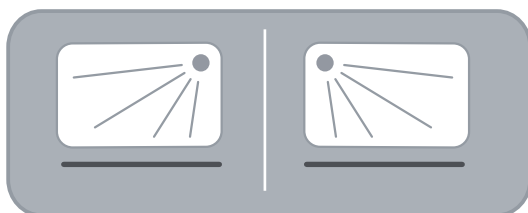

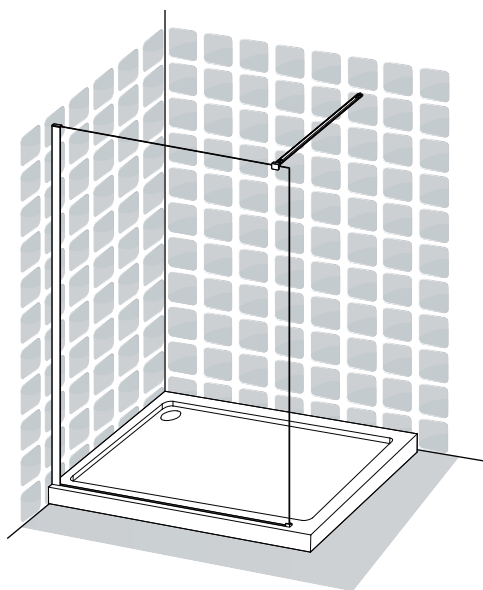

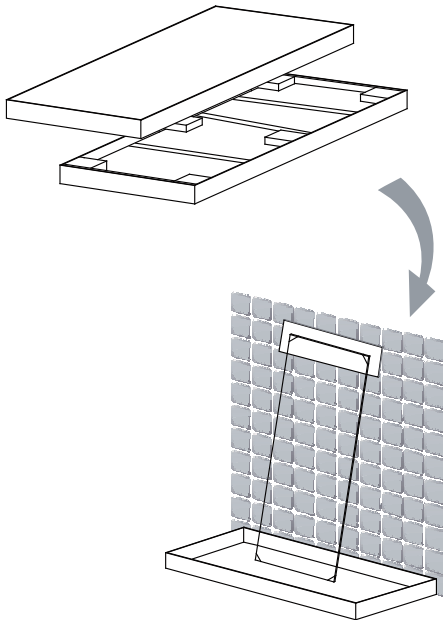

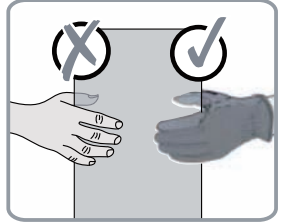
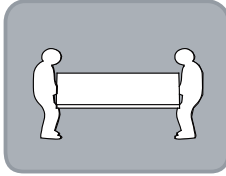
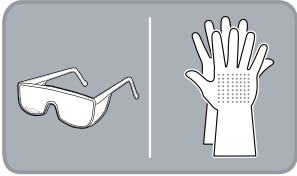
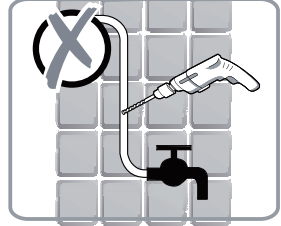
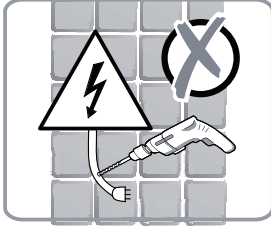
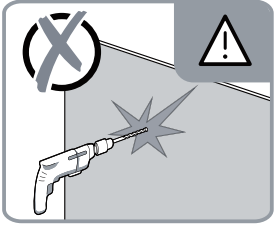
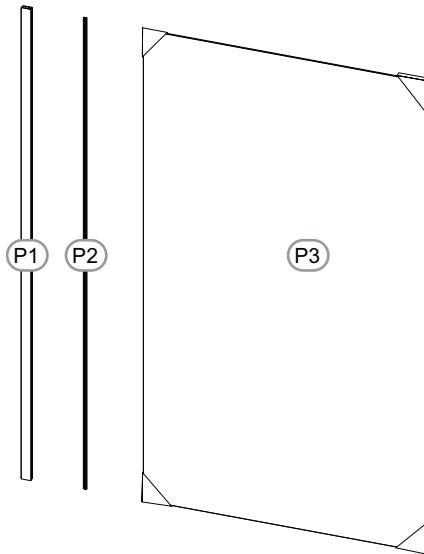
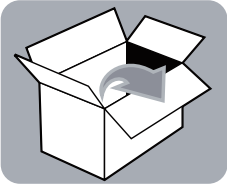
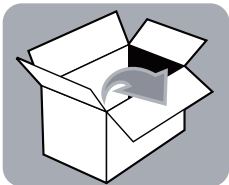

H1

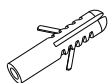

x5

H2



ST4x45mm

x5

H3

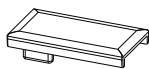

x1

H4

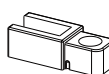

H5



x1

H13



x4

N



x1

x1

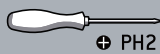
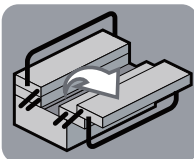

+ PH2

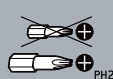

+ PH2



Ø 6mm

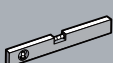
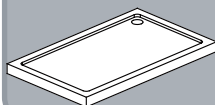
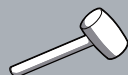

● 2mm



● 4mm

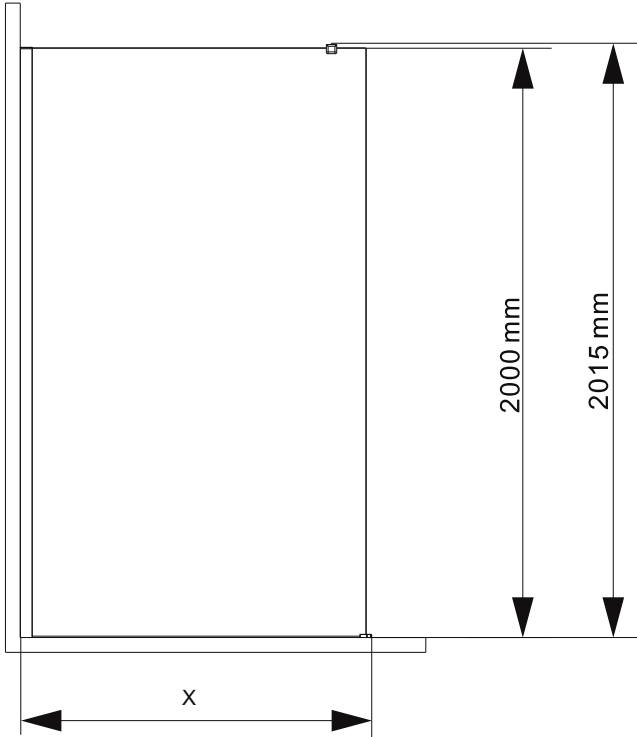
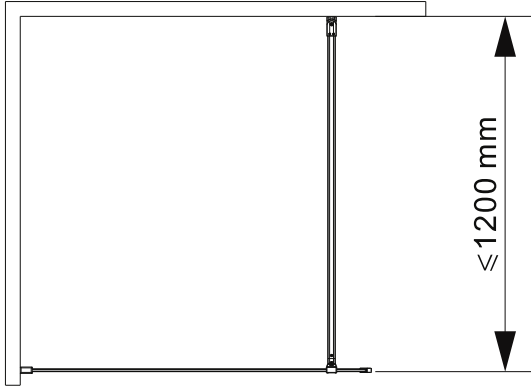

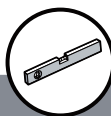
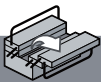
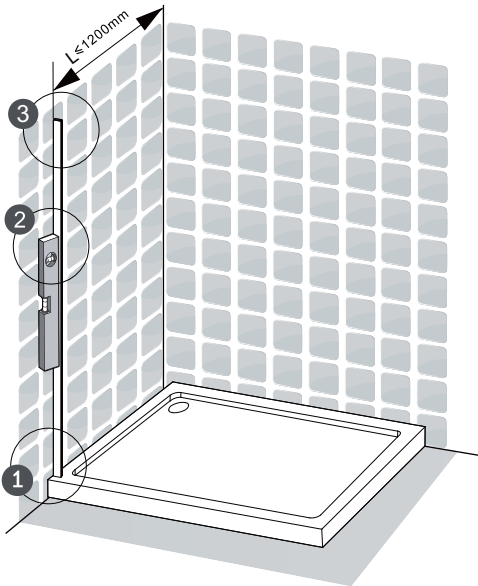
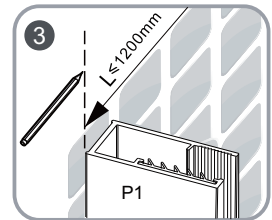
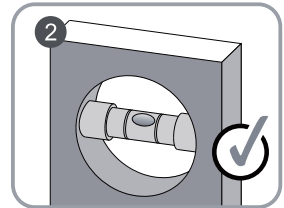
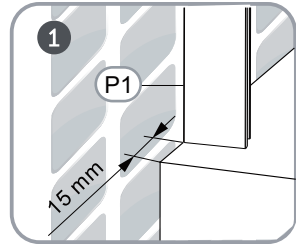
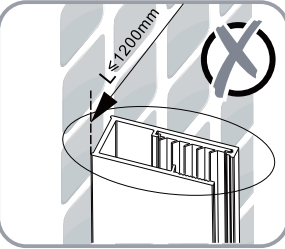
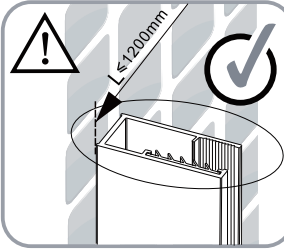

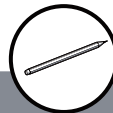
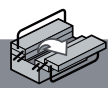
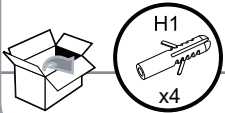
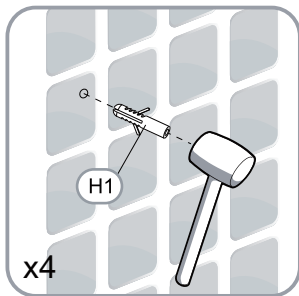
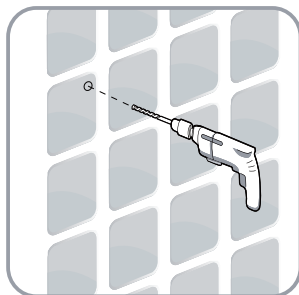
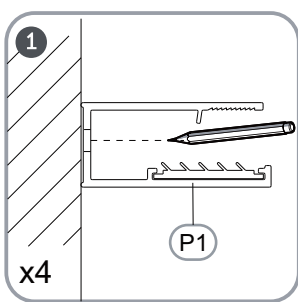
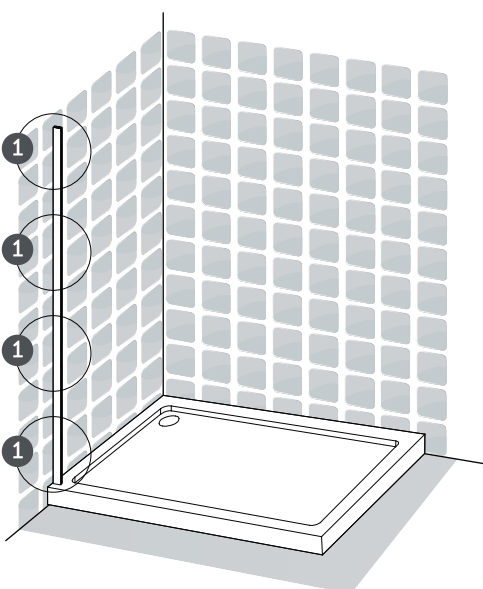

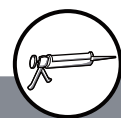
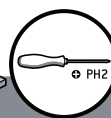
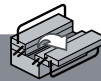
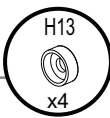
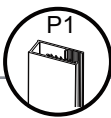
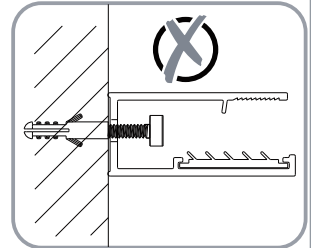
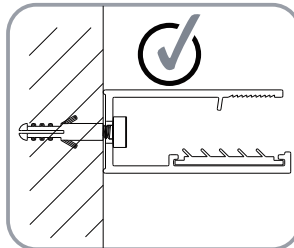
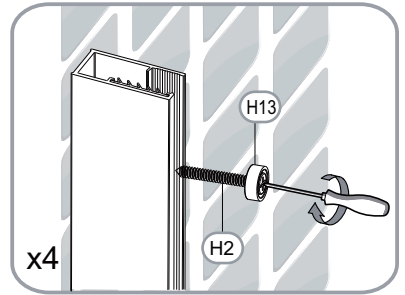
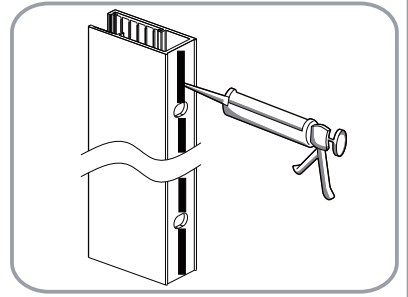
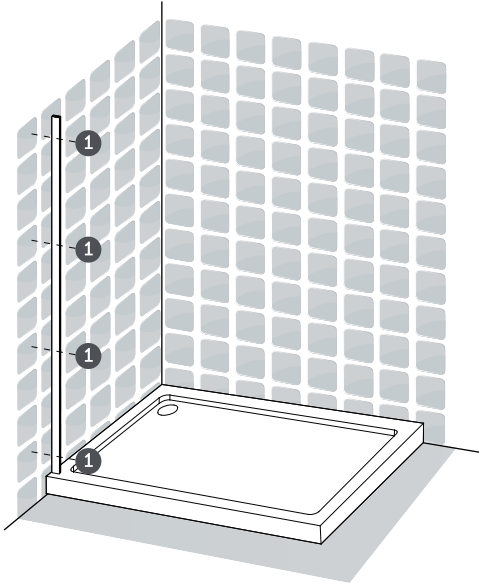

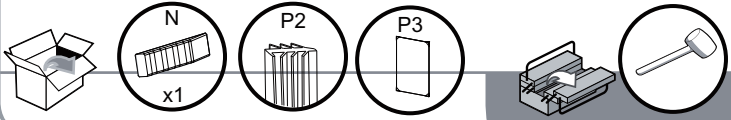
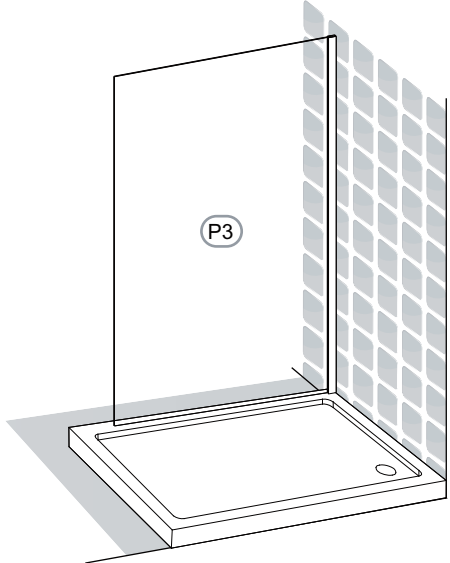
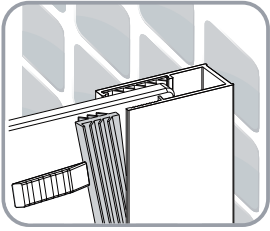
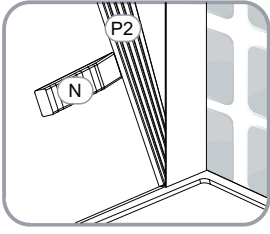
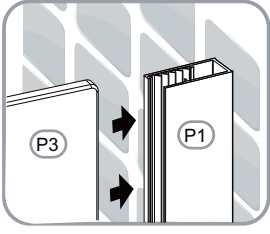
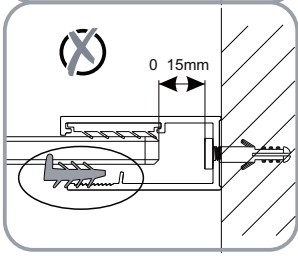
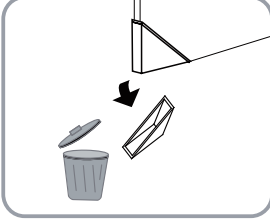
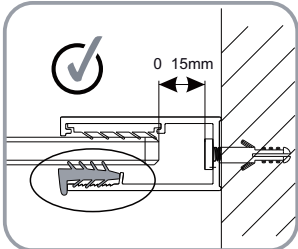
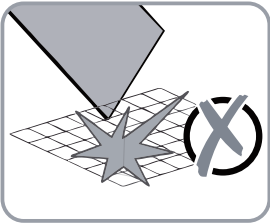

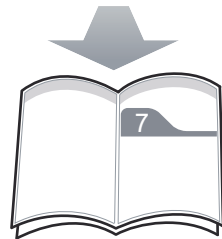
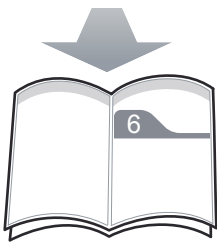
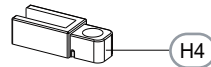
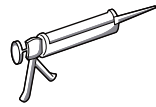
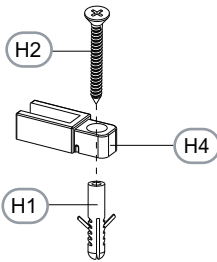
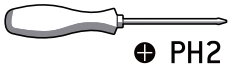
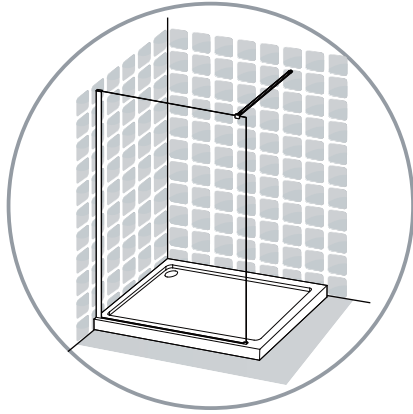

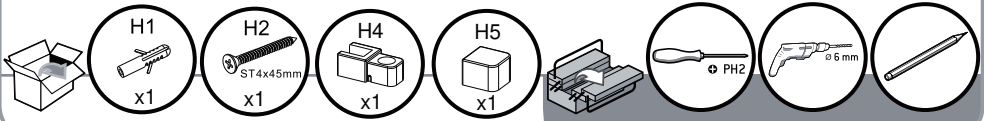
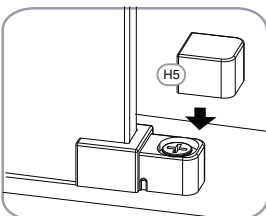
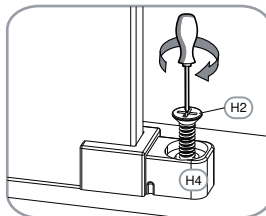
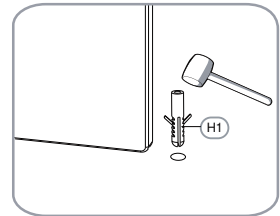
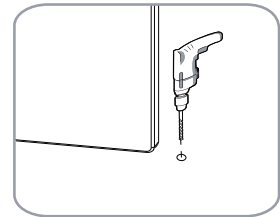
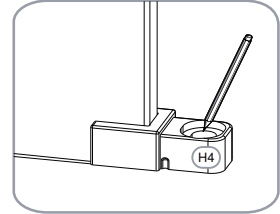
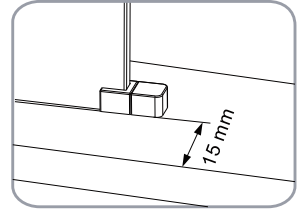
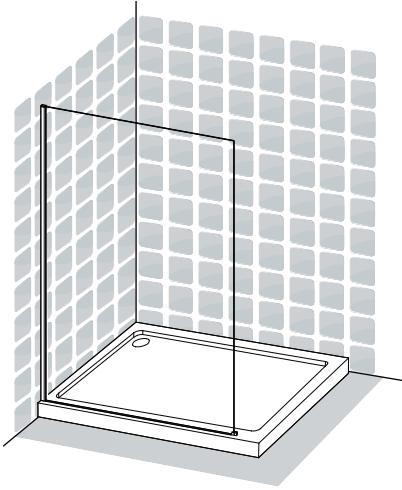

Achtung: Prüfen Sie die Beschaffenheit Ihres Fußbodens mit Ihrem Handwerker ob Bohrungen erlaubt sind. Bei Fußbodenheizungen und Duschwannen sind keine Bohrungen erlaubt.

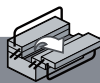
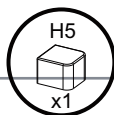
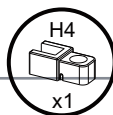
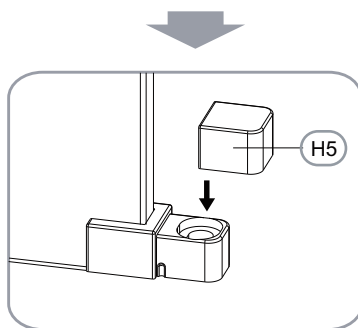
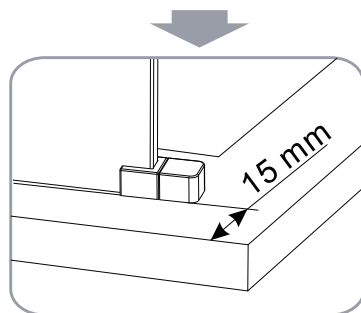
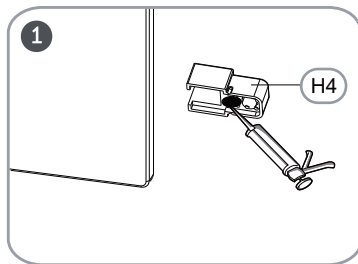
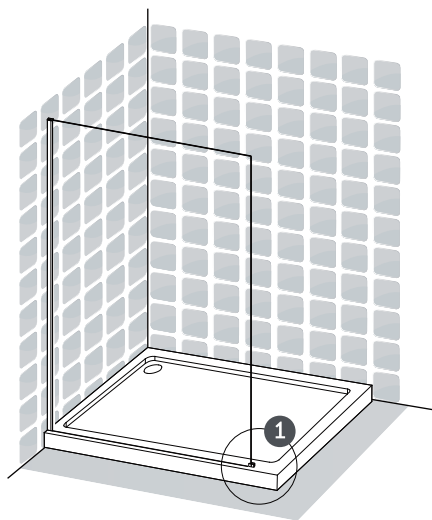

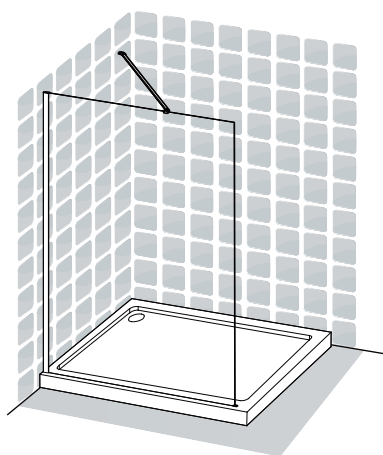
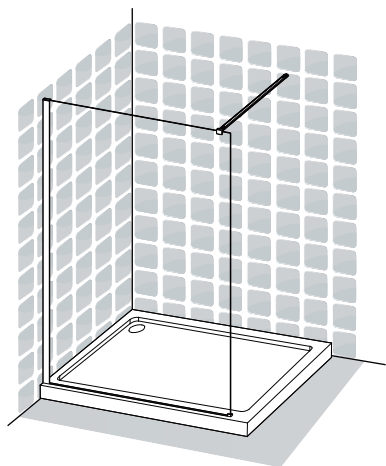

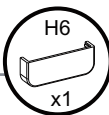
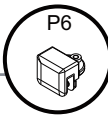
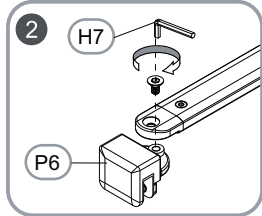
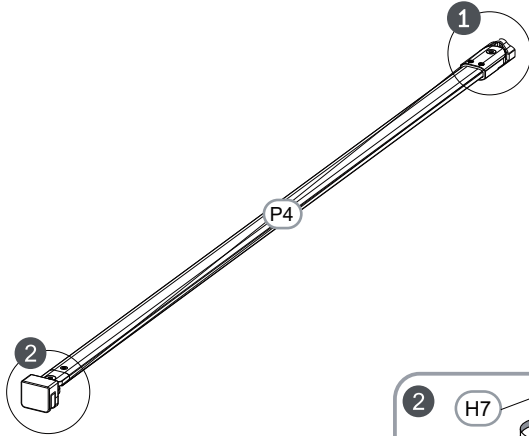
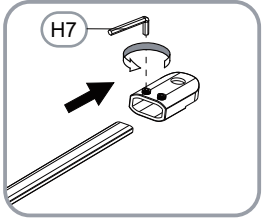
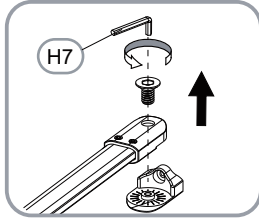
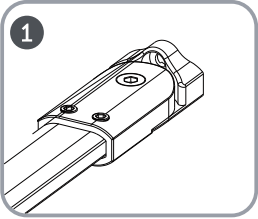
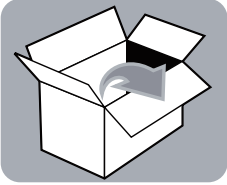

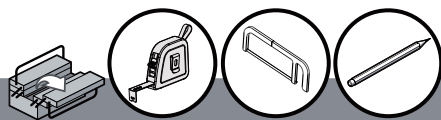
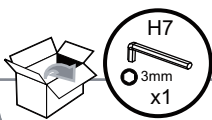
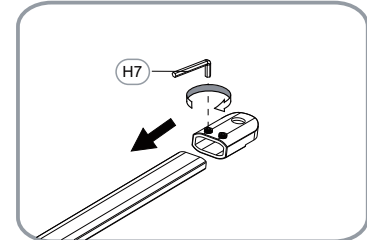
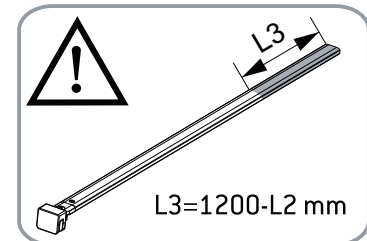
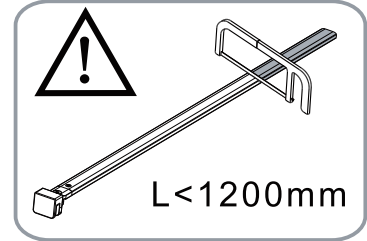
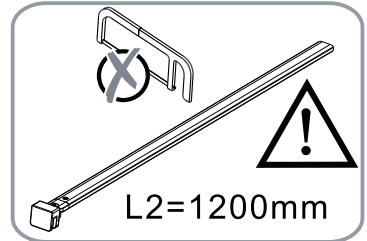
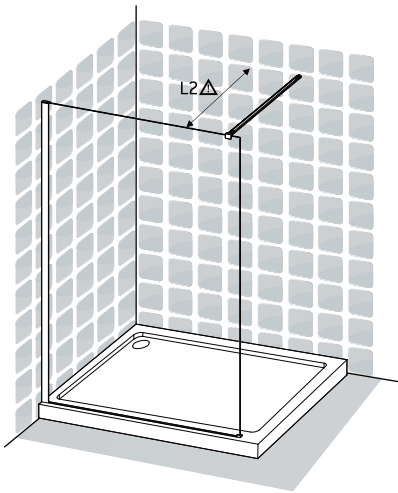
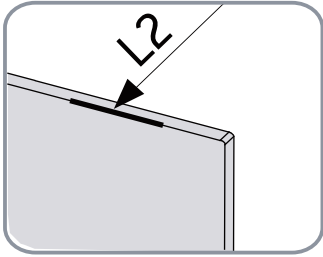

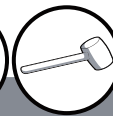
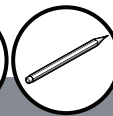
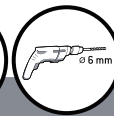
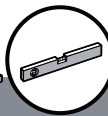
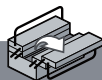
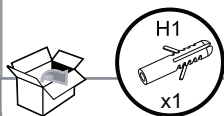
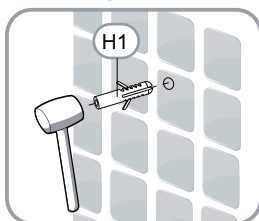
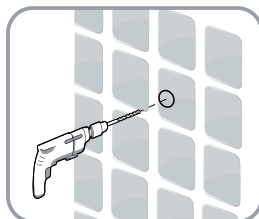
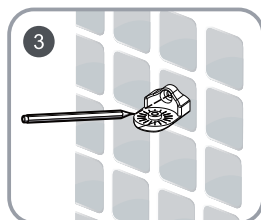
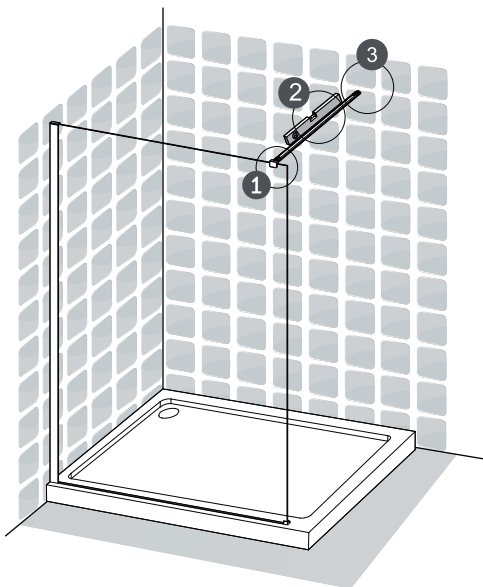
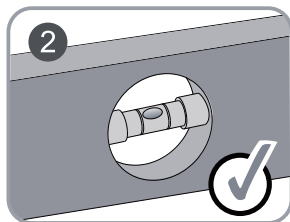
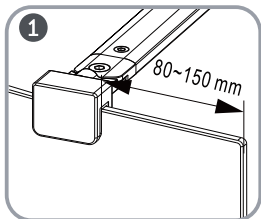

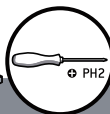
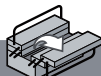
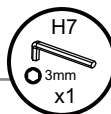
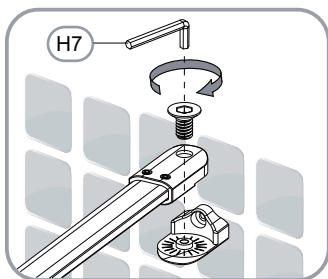
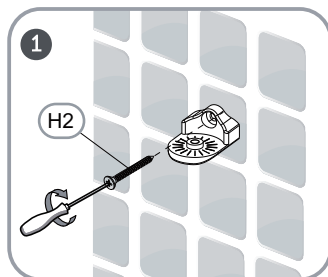
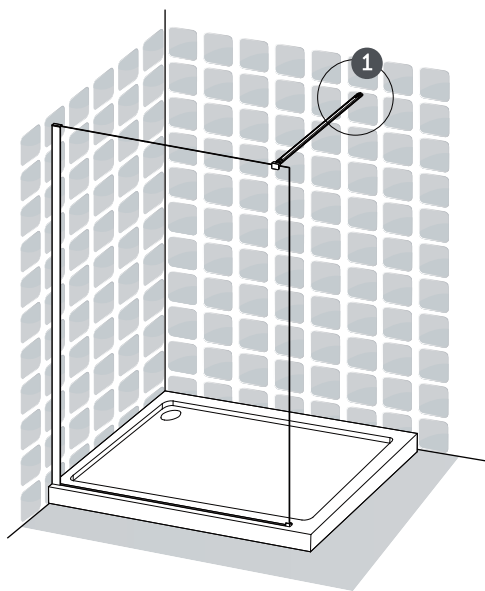

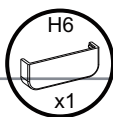
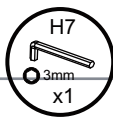
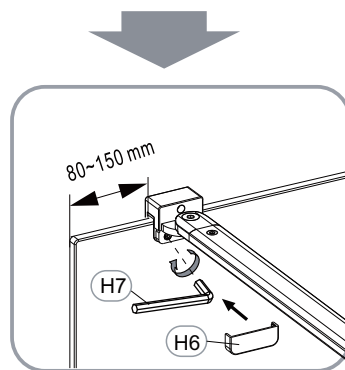
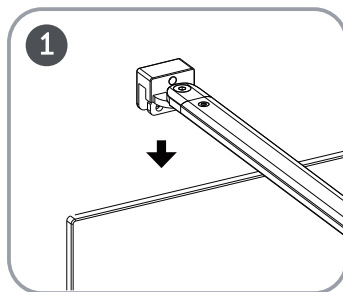
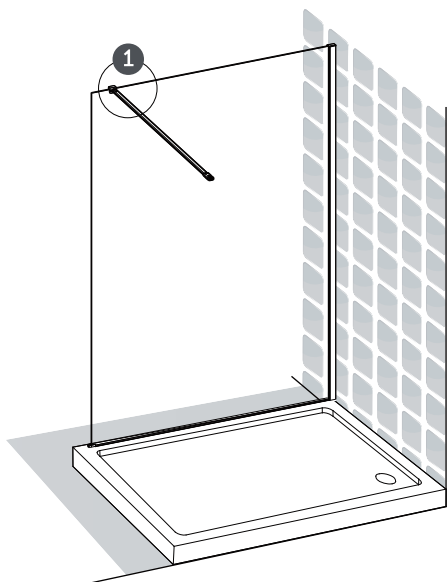

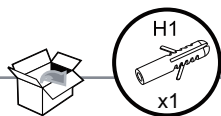
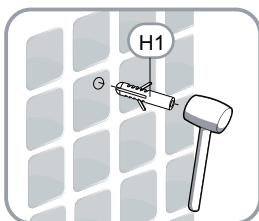
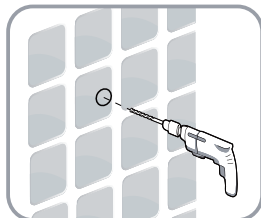
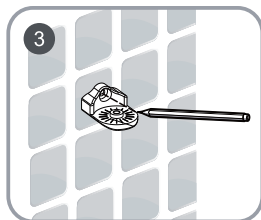
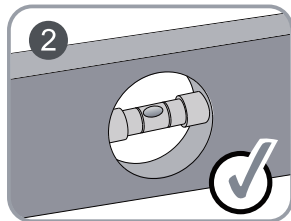
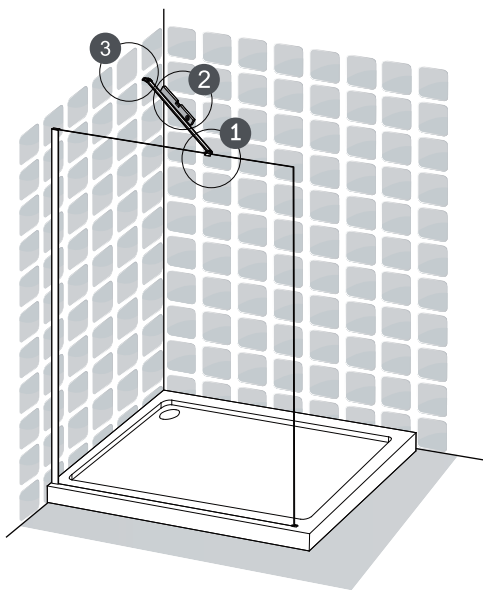
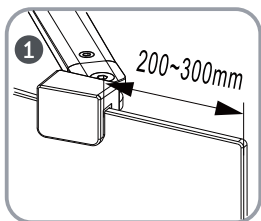

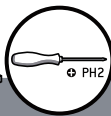
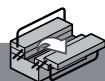
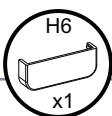
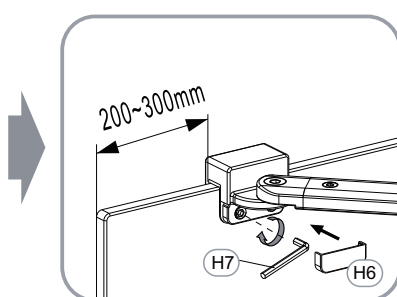
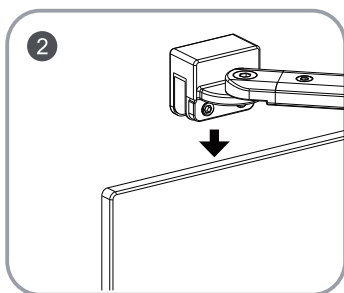
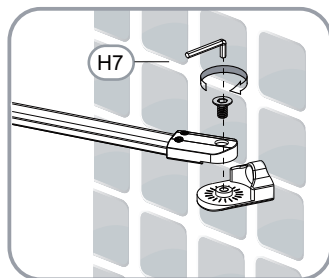
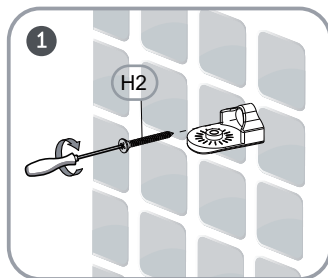
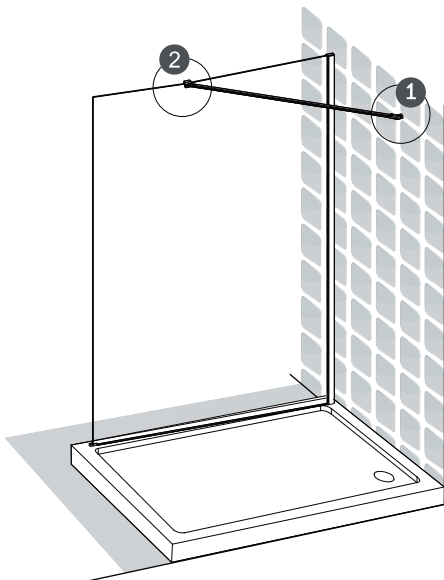

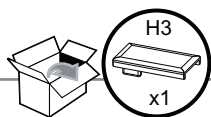
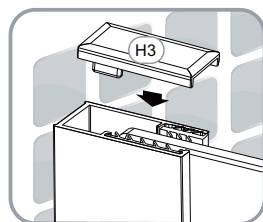
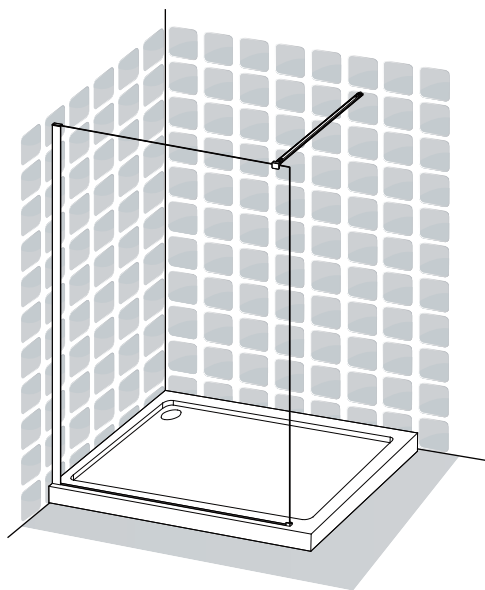

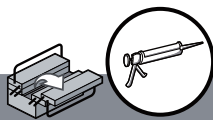
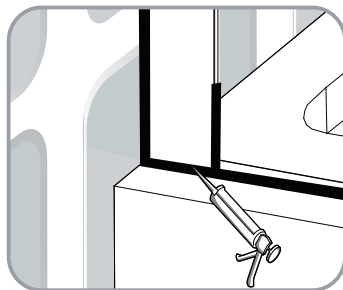
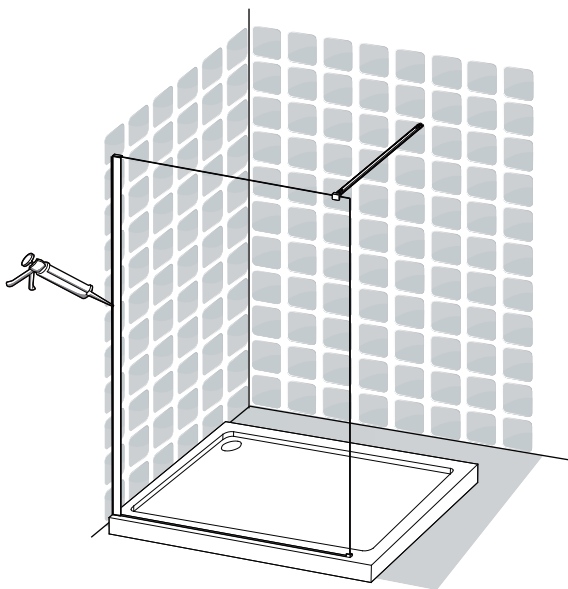

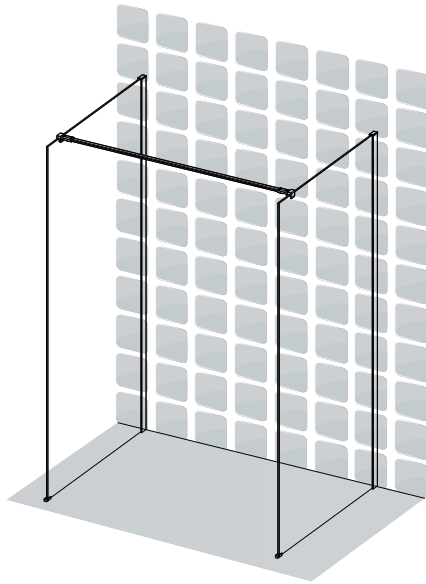
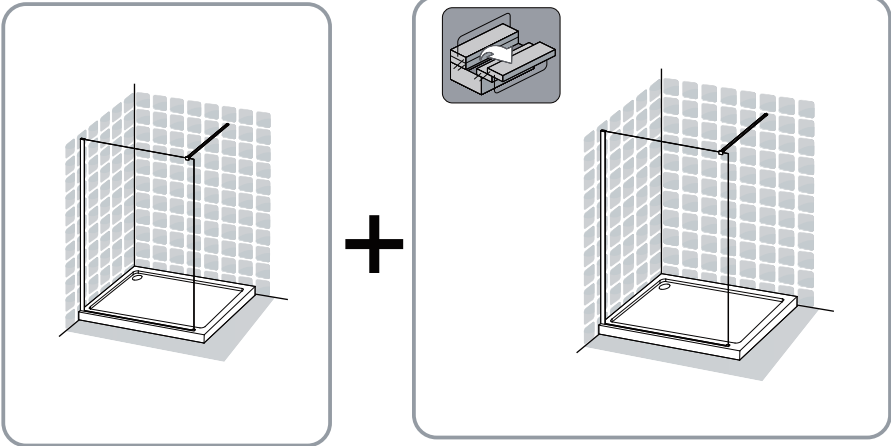

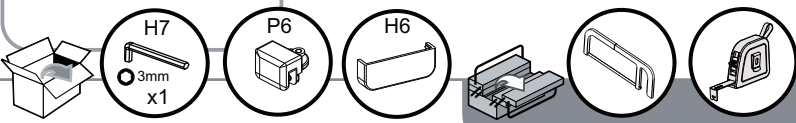
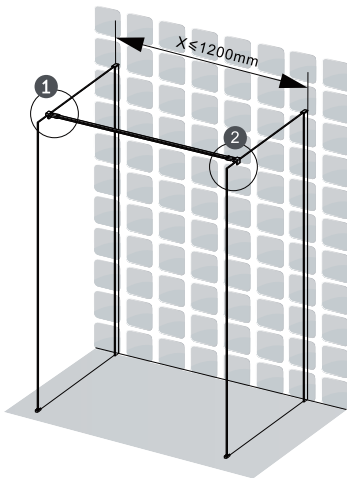
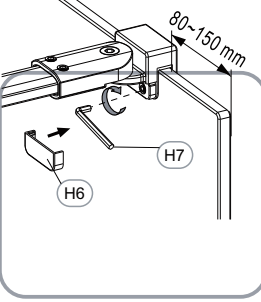
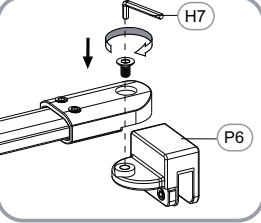
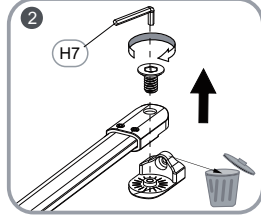
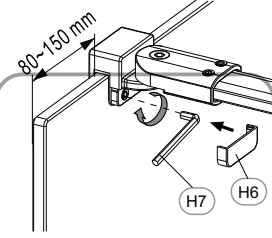
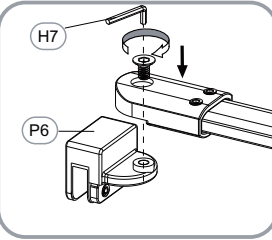
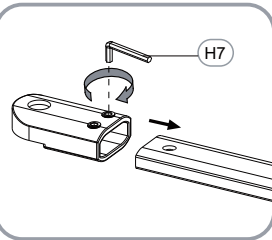
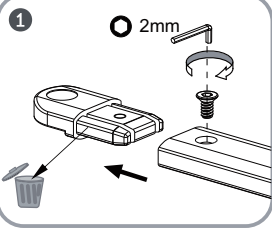



Lösungsmittel-Frei

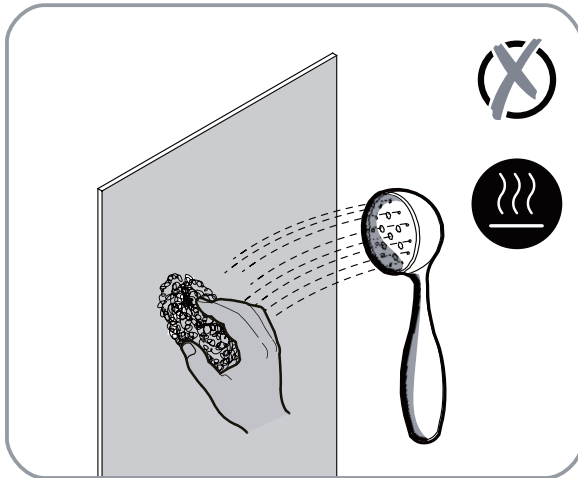
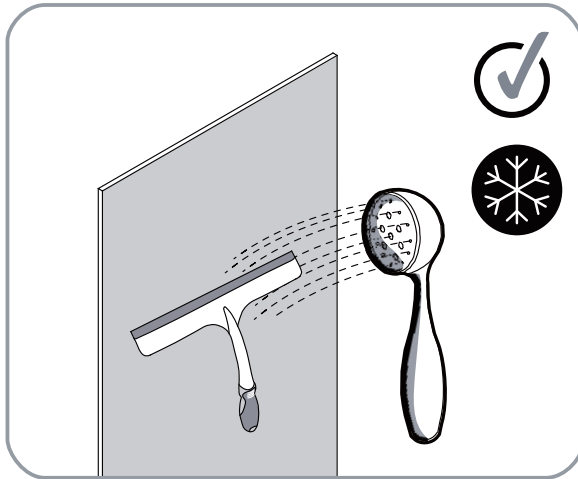



Duschmeister GmbH & Co KG
An der Strusbek 52a
22926 Ahrensburg bei Hamburg
Deutschland
19

Leistungserklärung:001/2019
EN 14428:2015+A1:2018

Verwendungszweck: Körperhygiene
SW8012011502

Reinigbarkeit:	Bestanden
Brucheigenschaften:	Bestanden
Dauerhaftigkeit:	Bestanden